

--

Datum:
Kunde:
Projekt:

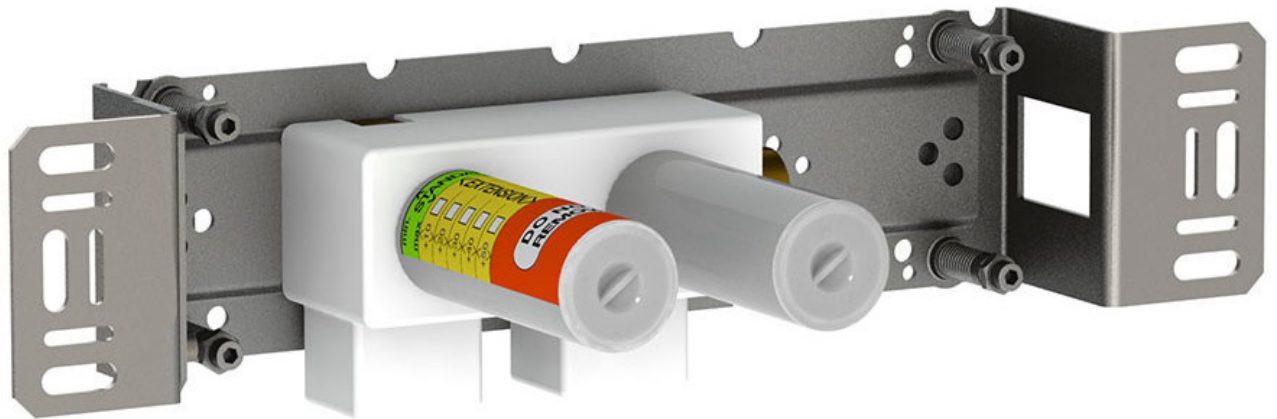

700V

Zweigriffmischer. Anschluss 1/2" Innengewinde.

Durchfluss

	Bar:	1,0	2,0	3,0	4,0	5,0
700V	(l/min)	34,6	49,0	60,0	69,3	77,5

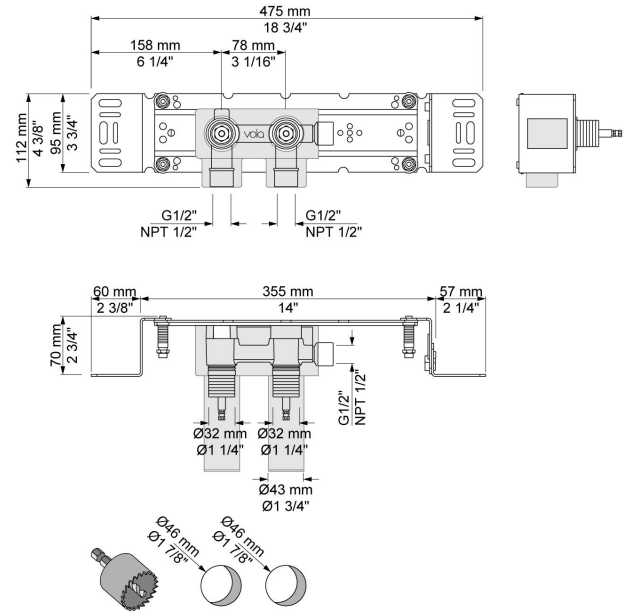

Lieferbar In Oberflächen