

--

Datum:
Kunde:
Projekt:

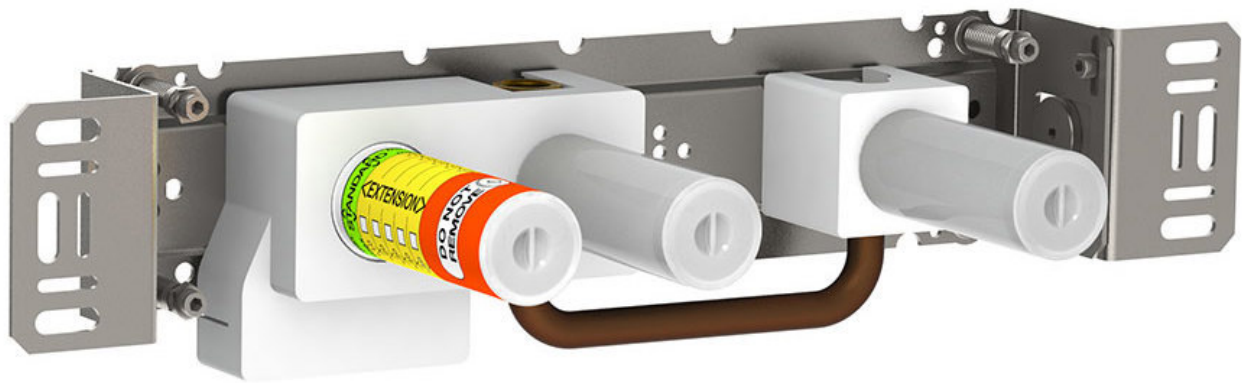

400FV

Eingriffmischer mit Umschalter für zwei Zwecke, mit einer fest montierten Auslaufmuffe. Abstand Auslaufmuffe 156 mm. Anschluss 1/2" Innengewinde.

Durchfluss

	Bar:	1,0	2,0	3,0	4,0	5,0
400FV	(l/min)	8,7	12,2	15,0	17,3	19,4

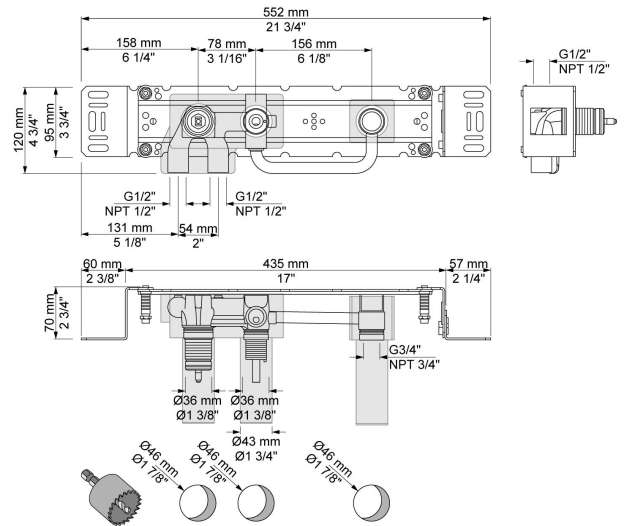

Lieferbar In Oberflächen