

VOLA NR.41
 VOLA VR512
 VOLA 4002/L/V, 4003

Do not cut the membrane
Die Membran nicht schneiden
Skær ikke membranen
Skär inte membranet
Snij het membraan niet door
Ne coupez pas la membrane
No cortar la membrana

NR.41:

1

VR512:
 4002/L/V:
 4003:

2

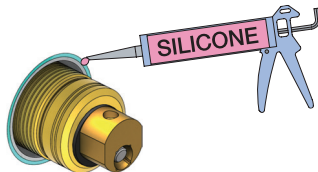

NR 41

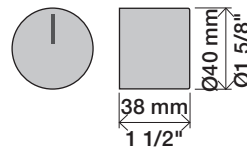

NR 41 - 1

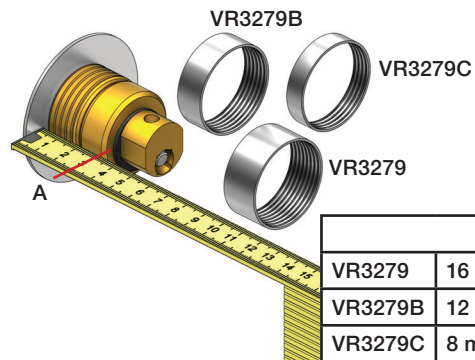

		A
VR3279	16 mm	31 - 36 mm
VR3279B	12 mm	27 - 32 mm
VR3279C	8 mm	23 - 28 mm

NR 41 - 2

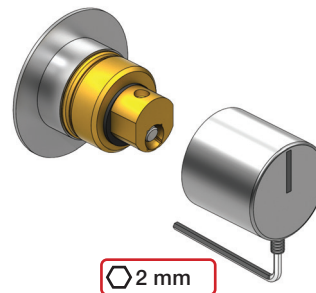

www.vola.com

vola

mnt_NR41_40998512_V1



©VOLA A/S 5 705230 296593

1

VR512
4002L

4002V
4003

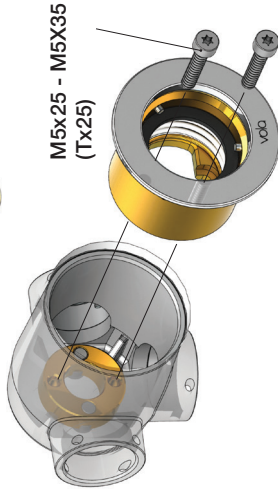
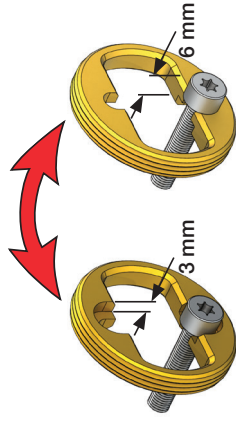

4002L/V:
4003:

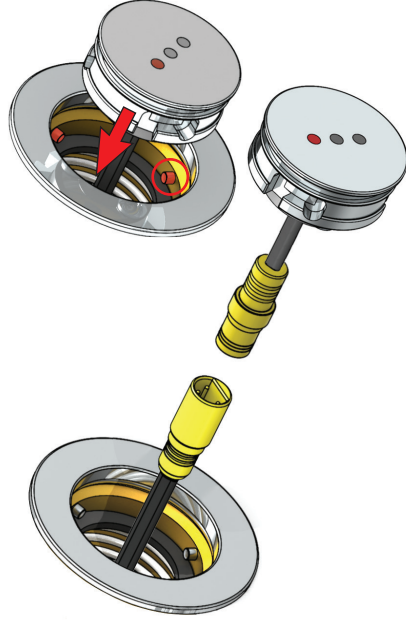
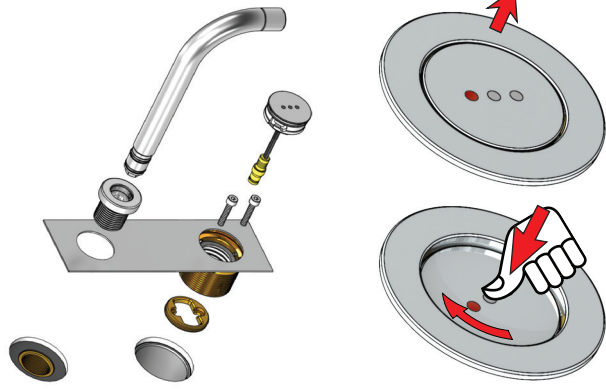

A: 10 - 20 mm = M5x25
A: 20 - 29 mm = M5x35

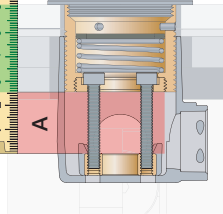
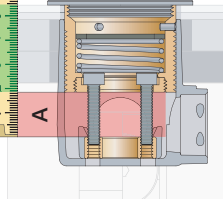

VR513A:	Standard
Tiles:	3 - 15 mm
Fliessen:	15 - 25 mm
Fliiser:	25 - 35 mm
Tegels:	35 - 45 mm
Carreaux:	45 - 55 mm
	55 - 65 mm